

TYPE F

Ref.: 156.405



ISO/PAS 11154



CITY CRASH TEST





n°405



Opel Astra SportsTourer (with railing) 5 2010->

Opel Zafira III 5 2011->

 } 5 kg +  xx Kg = **75 kg max**

Charge maximale admissible indiquée sur la boîte des barres de toit. Ne pas dépasser la charge maximale autorisée par le constructeur du véhicule.
Il Carico massimo ammissibile è indicato sulla scatola delle barre. Non superare il carico massimo consentito dal costruttore del veicolo.
Carga máxima admisible indicada en la caja de las barras de techo. No exceda la carga máxima permitida por el fabricante del vehículo.
Maximum allowable load indicated on the box of roof bars. Do not exceed the maximum load allowed by the vehicle manufacturer.

Maximal zulässige belastung angegeben auf der box der dachreling. Überschreiten sie nicht die maximale belastung durch den fahrzeughersteller zugelass.

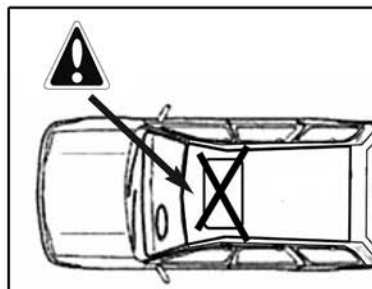
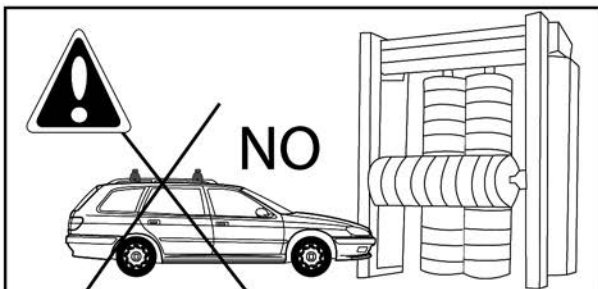
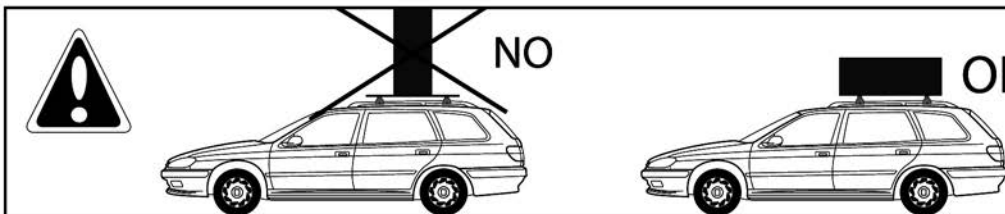
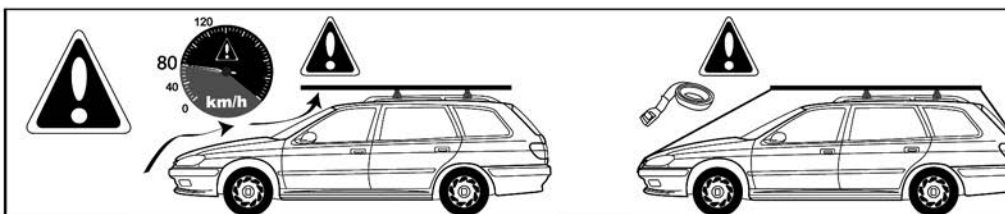



M6x20
x4



5588.06
x4



6592.06
x4



100005
X1

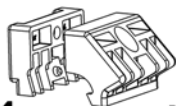

x4
1640507

x4
1740507

1

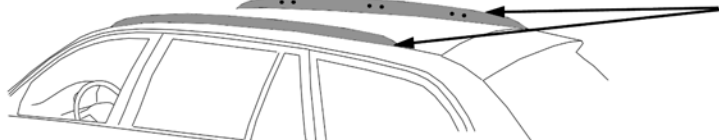

2

x4

1)

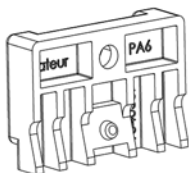

2)

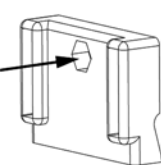

3)

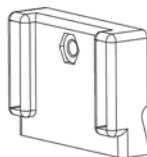

3

1640507

1740507

1640507

1740507

x1

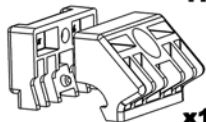

x1

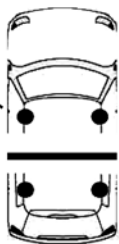

x1

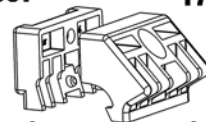

x1

1640507

1740507

1640507

1740507

x1

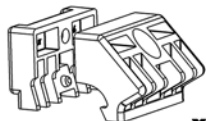

x1

x1

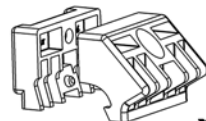

x1

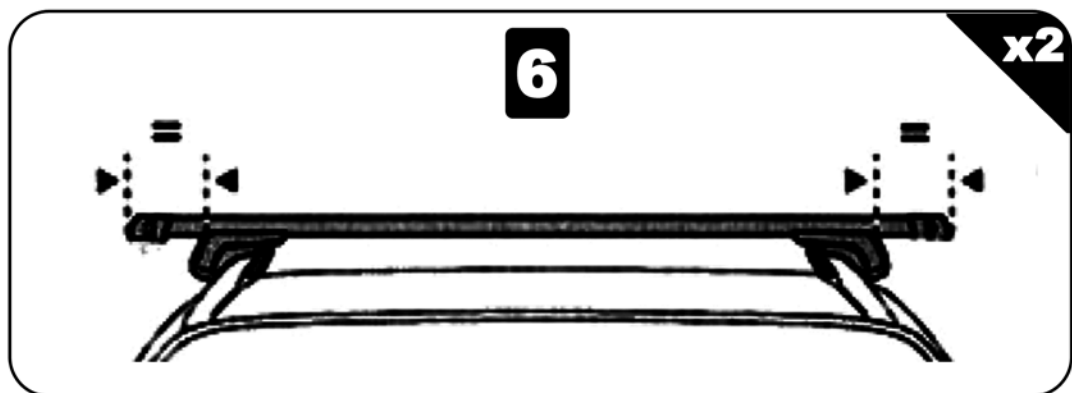
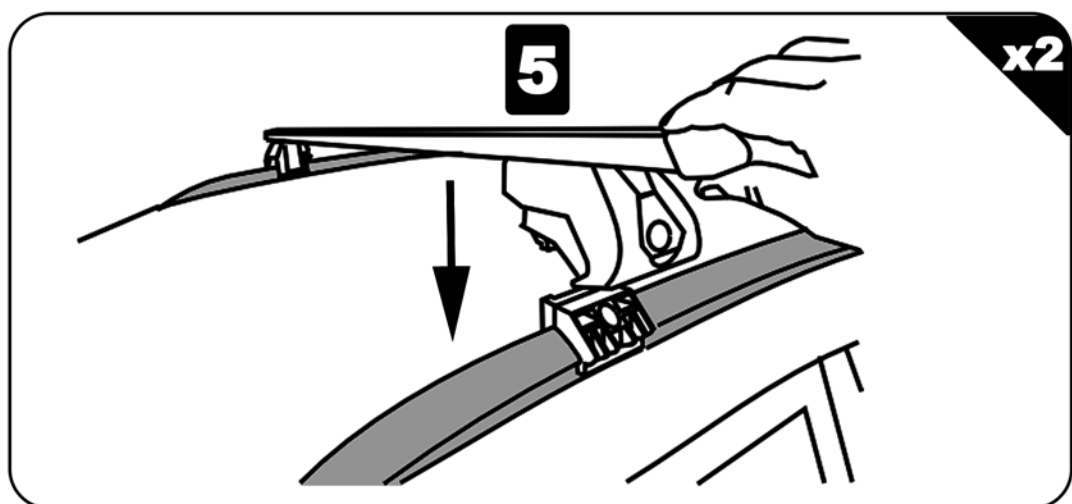
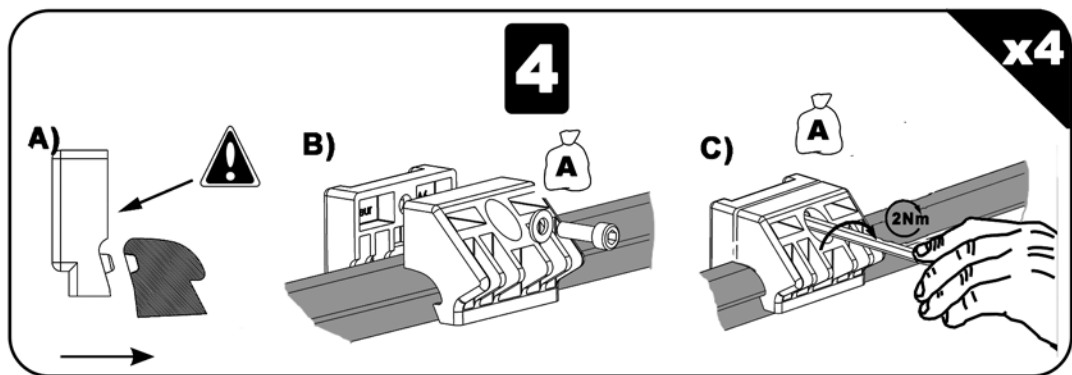

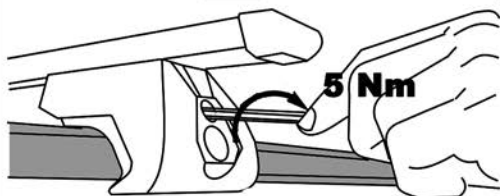
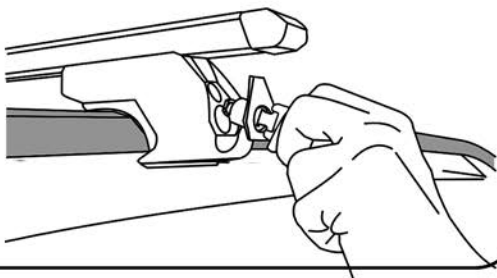
7**x4****8****x4**

FR: Charge maxi 75 kg ne pas dépasser la charge maximale admissible par le constructeur du véhicule.
IT: Carico massimo 75 kg non superare il carico massimo sul tetto indicato dal costruttore del veicolo.
SP: Capacidad máxima de carga 75 kg no exceda la maxima carga permitido por el fabricante del vehículo.
PT: Capacidade máxima de carga 75 kg não exceder a carga máxima permitida pelo fabricante do veículo.
EN: Maximum carrying capacity 75 kg do not exceed the maximum allowable load by the vehicle manufacturer.
DE: Zulässige höchstlast 75 kg überschreiten sie nicht die maximale belastung zulässige vom fahrzeughersteller.
NL: Maximaal toegestaan 75 kg neem niet meer de maximale belasting toegestane door de voertuigfabrikant.

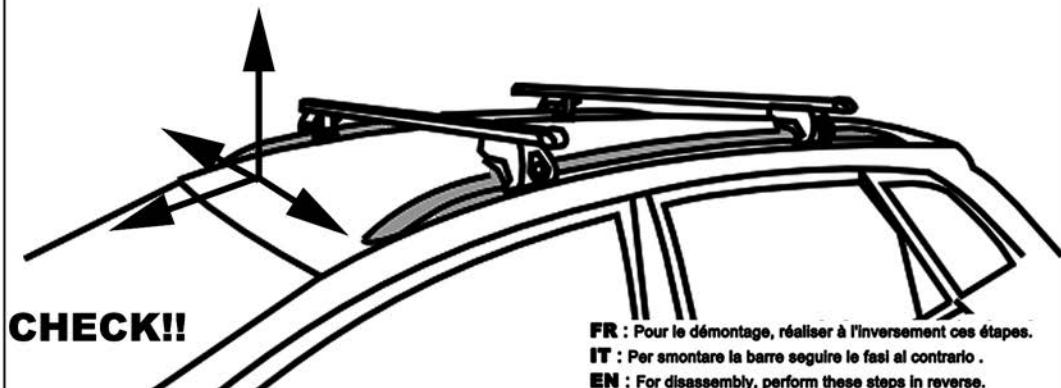

FR : Pour le démontage, réaliser à l'inversement ces étapes.
IT : Per smontare la barre seguire le fasi al contrario .
EN : For disassembly, perform these steps in reverse.
ES : Para desmontar, siga estos pasos a la inversa.
PT : Para desmontar, execute estas etapas em ordem Inversa
NL : Uit elkaar te halen, voert u deze stappen in omgekeerde.
DE : Zu zerlegen, diese Schritte in umgekehrter