



CITY CRASH TEST



MAX 75 KG



ISO PAS 11154

**156.303**

5



09/2011-&gt;

LAND ROVER Evoque



$$\left. \begin{array}{l} \text{Roof rack} \\ \text{Kit} \end{array} \right\} ??? \text{ KG} + \text{xx Kg} = \text{MAX 75 Kg}$$

Ne pas dépasser le poids total autorisé en charge (PTAC) sur le toit du véhicule.

No debe sobrepasarse el peso total permitido sul techo del vehículo motorizado

Non superare il peso complessivo ammesso sul tetto del veicolo

Das zulässige Gesamtgewicht des Kraftfahrzeuges darf nicht überschritten werden

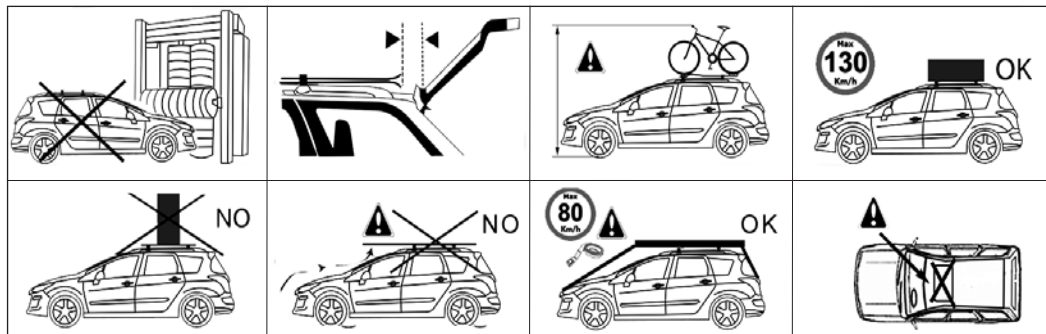



M6X50 mm

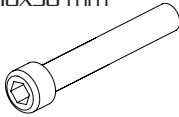

x4

162100001

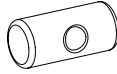

x4

6592.06



x4

94013

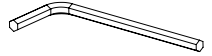

x1

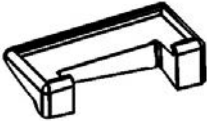

x1

1123501

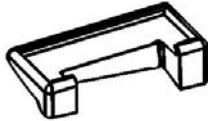

x1

1123502

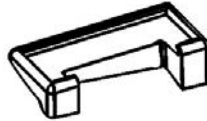

x1

1127603

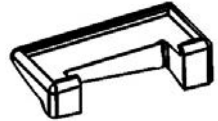

x1

1127604

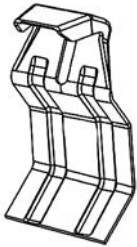

x4

26000



x4

3540827

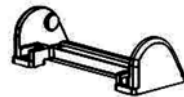

x4

81018

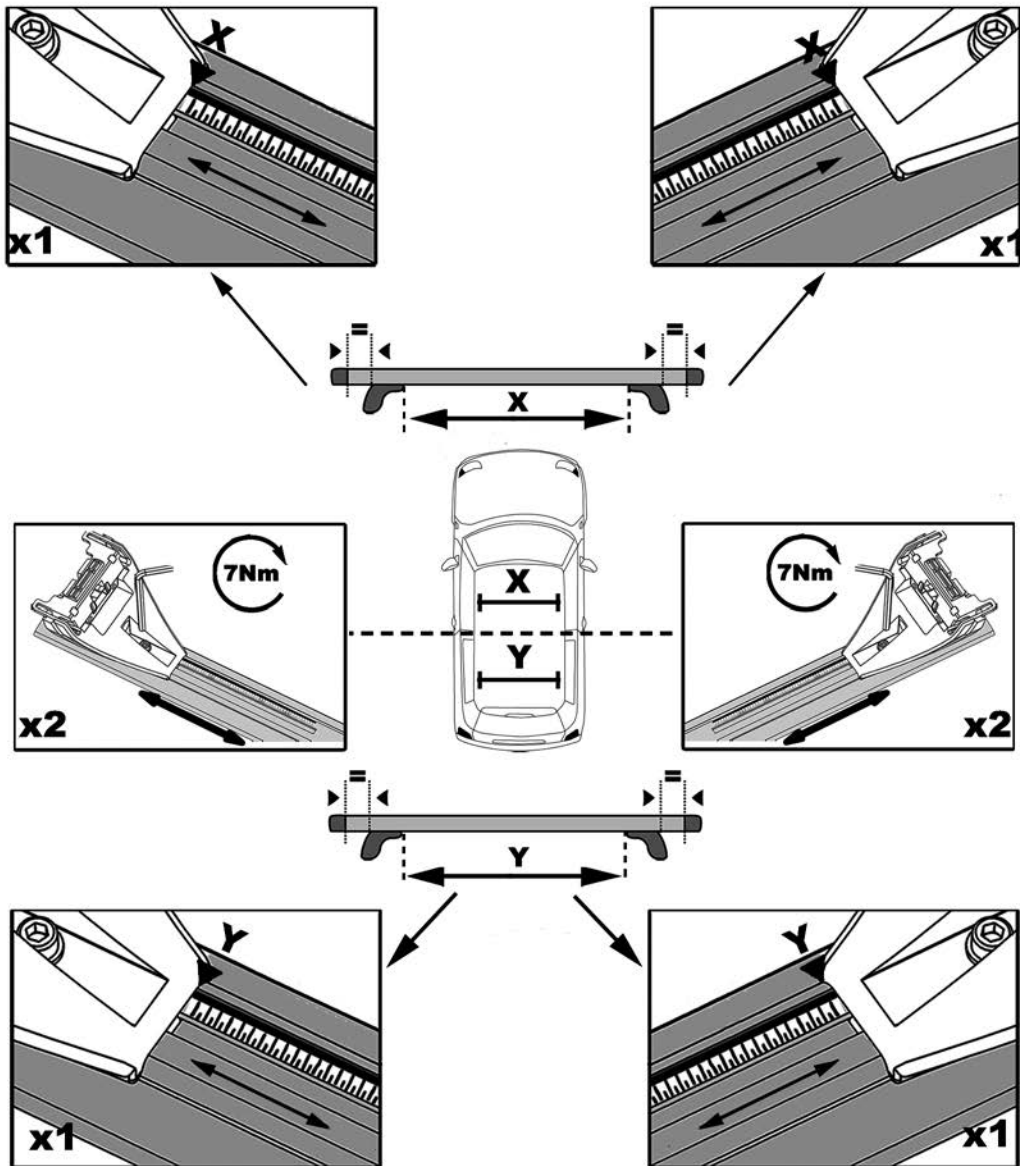

BRAND	MODEL	X	Y
Land Rover	Evoque	97.5 Cm	99.5 Cm



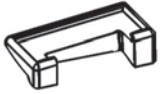

1123501

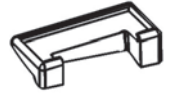

1123502



26000



26000

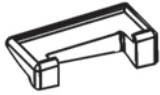
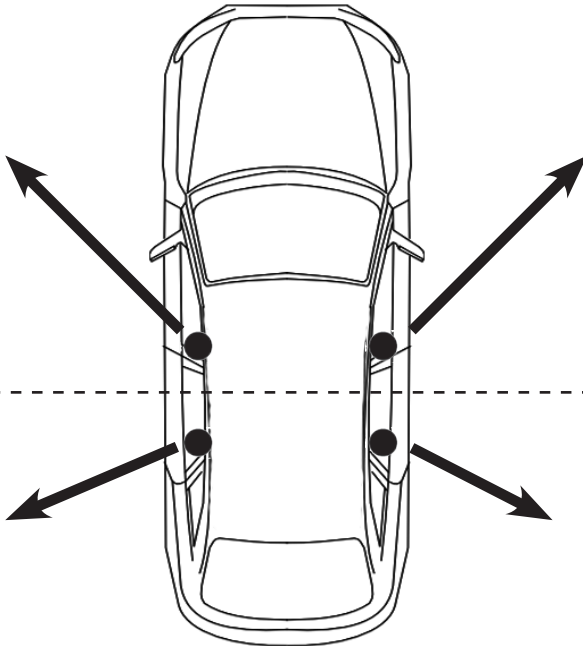

1127603

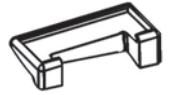

1127604



26000



26000

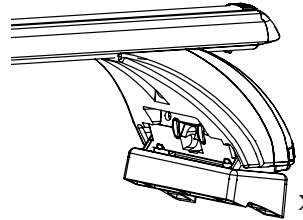
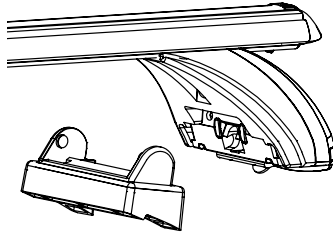
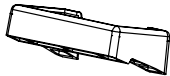
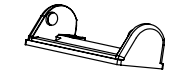

x4

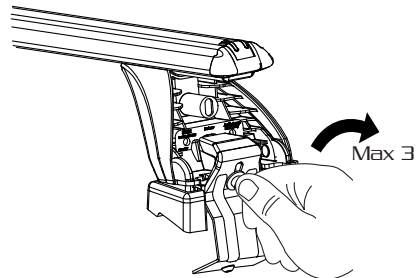
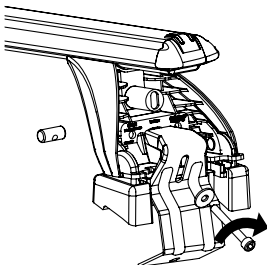

x4

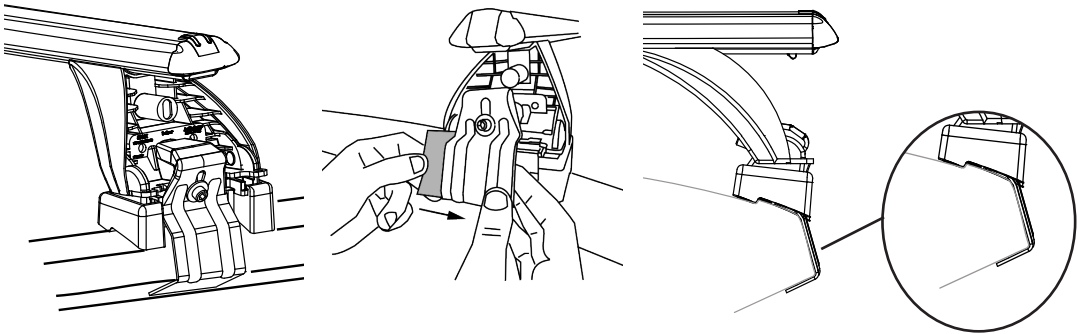
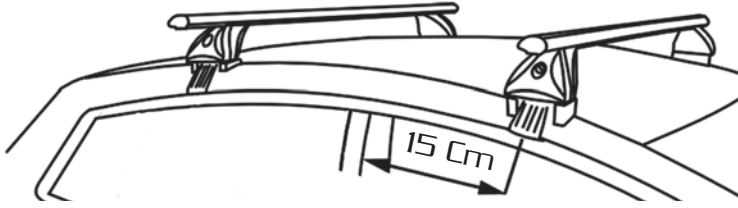

EN: Tighten alternately  
 IT: Serrare in modo alternato  
 DE: Die Schrauben abwechselnd anziehen

FR: Serrer alternativement chaque côté  
 ES: Alternar el serraggio delle viti

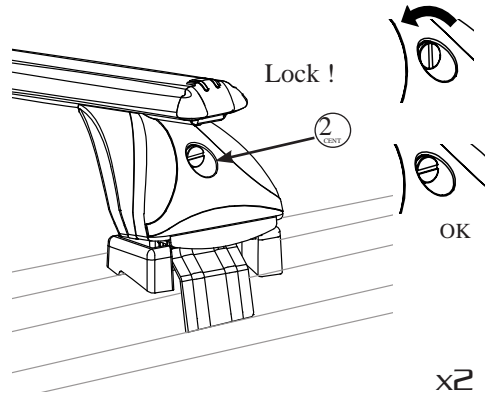
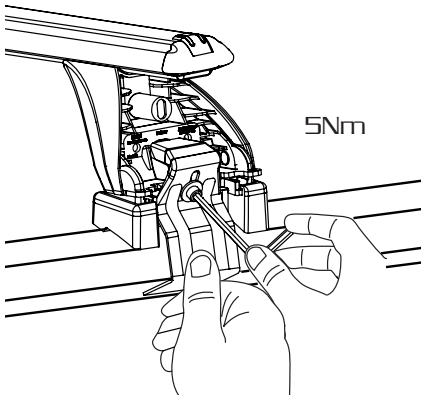

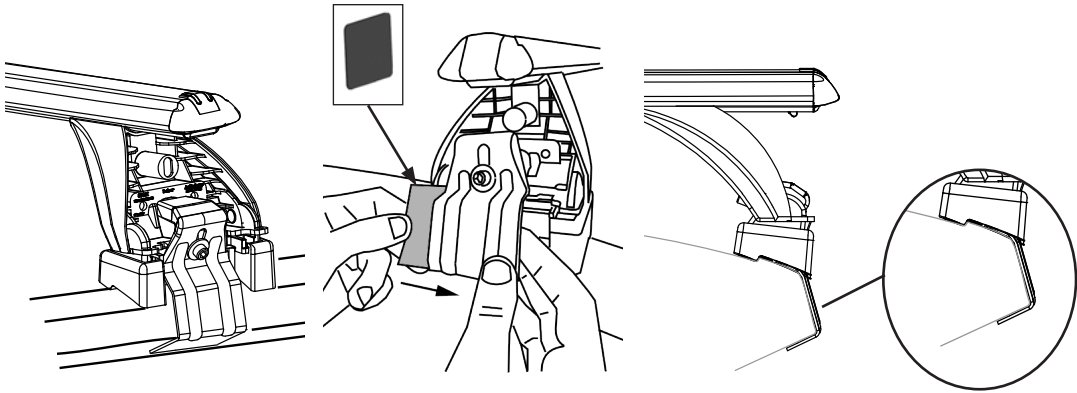
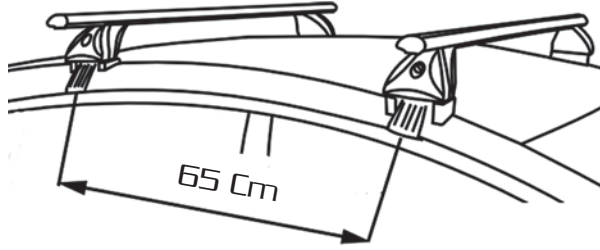

EN: Tighten alternately  
 IT: Serrare in modo alternato  
 DE: Die Schrauben abwechselnd anziehen

FR: Serrer alternativement chaque côté  
 ES: Alternar el serraggio delle viti

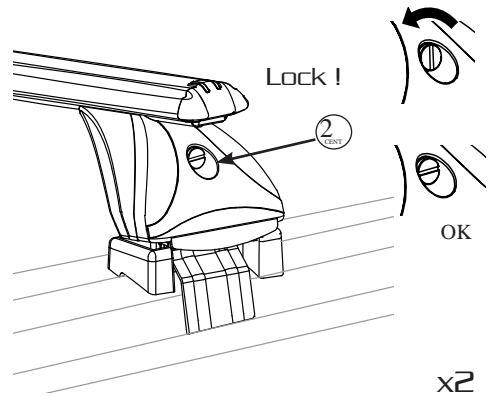
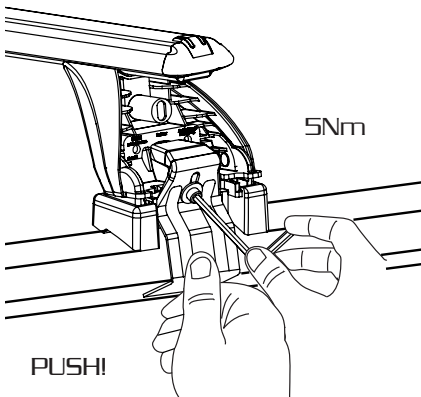

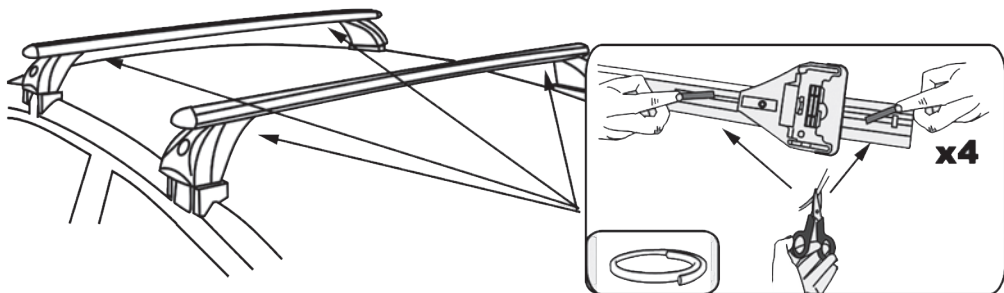
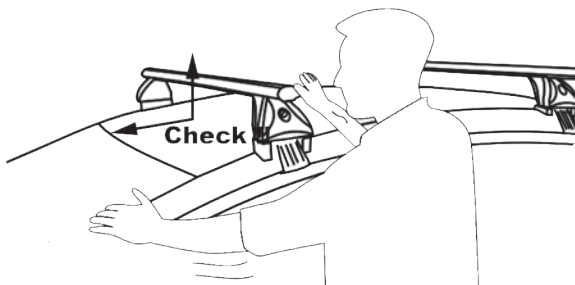
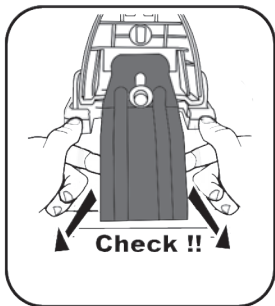

**EN:** Uninstall **FR:** Démontage **IT:** Smontaggio **DE:** Demontage

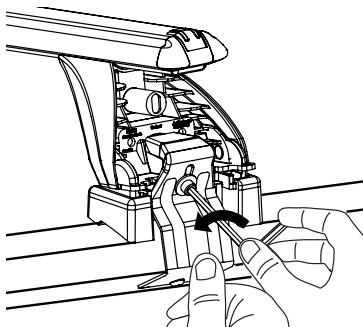
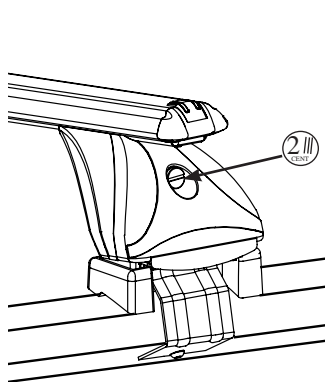

FR: Suivre les indications de montage et les instructions d'utilisation répertoriées dans la notice fournie. Conserver ce manuel sans limitation de durée.  
Capacité maximale de charge autorisée 75 kg. Ne pas dépasser le poids total autorisé en charge (PTAC) du véhicule. Les consignes du constructeur du véhicule concernant la charge de toit maximale doivent être respectées. Détermination de la charge de toit effective : poids des barres de toit + poids du coffre de toit + poids de la charge transportée = charge de toit effective  
Il est indispensable que la charge soit fixée d'une manière sûre et adéquate.  
Le serrage des dispositifs de fixation et des pièces de sécurité, des barres porte-charges de toit, ainsi que des accessoires ajoutés doivent être vérifiés après chaque chargement et régulièrement pendant le trajet. Resserrer si nécessaire.  
Dans tous les cas respecter la réglementation en vigueur.  
La charge doit être uniformément répartie sur les barres et le centre de gravité le plus bas possible  
Veillez à placer les charges lourdes et étroites près des pattes de fixation des barres.  
Il est nécessaire que les chargements débordants des barres remplissent de la réglementation en vigueur et soient convenablement arimés.  
Toute charge transportée sur le pavillon d'un véhicule affecte d'une manière sensible son comportement, en particulier la sensibilité au vent latéral et le comportement en virage et au freinage. Il est conseillé de conduire avec plus de prudence (réduire la vitesse, tenir compte de l'augmentation des distances de freinage).  
Afin de réduire la consommation de carburant, il est conseillé d'ôter les barres porte-charges de toit après utilisation.  
Attention: Utiliser un matériel fiable et bien entretenu, vérifier son bon état avant et après chaque utilisation.  
La barre de toit peut être utilisée exclusivement pour les affectations mentionnées par le producteur.  
Il est important de garder les instructions de montage et utilisation.  
Les accessoires de toit peuvent provoquer du bruit ou turbulence lors de leur utilisation.  
Ne pas utiliser en combinaison avec des tentes toit.  
Ne jamais dépasser la limite de vitesse indiquée sur la première page du manuel.  
En cas de doute quant à la fixation ou l'utilisation, s'il vous plaît contactez le distributeur Green Valley le plus proche.

ES: Seguir las indicaciones de montaje y las instrucciones de utilización indicadas en las instrucciones proporcionadas. Conservar siempre este manual.  
Capacidad máxima de carga autorizada 75 kg. No debe sobrepasarse el peso total permitido del vehículo motorizado. Deben atenderse las instrucciones del fabricante del vehículo en relación a la carga máxima del techo.  
Cálculo de la carga de techo existente: Peso de las barras portaequipajes + Peso del cofre de techo + Peso de la carga = Carga del techo existente  
Es indispensable que la carga se fije de forma segura y adecuada.  
Los ajustes de los dispositivos de fijación y de las piezas de seguridad, de las barras portacargas del techo, y de sus accesorios añadidos deben ser verificados tras cada carga y regularmente durante el trayecto. Reajustar si es necesario.  
Carga máxima admisible indicada en la caja de las barras de techo. No exceda la carga máxima permitida por el fabricante del vehículo.  
En todos los casos respetar la normativa vigente.  
La carga debe estar uniformemente repartida sobre las barras y el centro de gravedad lo más bajo posible.  
Por favor, coloque las cargas pesadas y estrechas cerca de las patas de fijación de las barras.  
Es necesario que las cargas que sobresalgan de las barras cumplan las prescripciones de la normativa vigente y estén convenientemente fijadas.  
Toda carga transportada sobre el techo de un vehículo afecta de forma sensible su comportamiento, en particular la sensibilidad al viento lateral y el comportamiento en las curvas y en el frenado. Se aconseja conducir con más prudencia (reducir la velocidad, tener en cuenta el aumento de la distancia de frenado).  
Con el fin de reducir el consumo de combustible, se aconseja quitar las barras portacargas del techo después de su utilización.  
Atención: Utilizar un material fiable y bien conservado, verificar su buen estado antes y después de cada uso.  
La barra del techo puede ser utilizada exclusivamente para las aplicaciones indicadas por el productor.  
Es importante guardar las instrucciones de montaje y de utilización.  
Los accesorios del techo pueden producir ruido o turbulencias durante su utilización.  
No utilizar en combinación con carpas de techo.  
No utilizar el accesorio acoplado a sistemas de fijación para otras marcas.  
No sobrepasar nunca el límite de velocidad indicado en la primera página del manual.  
En caso de duda en cuanto a la fijación o a la utilización, contacte, por favor, con el distribuidor Green Valley más cercano.

IT : Seguire le indicazioni di montaggio e le istruzioni di utilizzo indicate nel manuale fornito. Conservare il manuale senza limiti di tempo  
Capacità di carico massimo ammissibile sul prodotto 75 kg. Non superare il peso complessivo ammesso del veicolo. Rispettare le indicazioni del produttore del veicolo relativamente al carico massimo sul tetto, determinazione del carico effettivo sul tetto: peso delle barre portatutto + peso del box portabagagli + peso del carico = carico effettivo sul tetto  
Fissare sempre il carico in modo adeguato e sicuro  
La chiusura dei dispositivi di fissaggio e dei pezzi di sicurezza, delle barre portatutto, e di tutti gli accessori utilizzati, devono essere verificati dopo ogni utilizzo e regolarmente durante il tragitto, se necessario riprendere la coppia di chiusura.  
In ogni situazione , rispettare sempre le norme in vigore.  
Il carico deve sempre essere uniformemente distribuito sulle barre, il centro di gravità deve essere il più basso possibile .  
Cercare di posizionare i carichi più pesanti . In corrispondenza dei fissaggi delle barre portatutto.  
Tutti i carichi debordanti dalle barre portatutto soddisfino i requisiti della regolamentazione in vigore, fissare i carichi debordanti in modo corretto [ se possibile sfrattare i ganci di traino del veicolo posti in corrispondenza dei paraurti].  
Tutti i carichi trasportati sul tetto del veicolo, incidono sensibilmente sul comportamento del veicolo. In particolare la sensibilità al vento laterale ed il comportamento in curva e in frenata. Consigliamo sempre di condurre il veicolo con molta prudenza ( ridurre la velocità, avendo conto dell'aumento degli spazi di frenata).  
Al fine di ridurre il consumo di carburante, consigliamo di smontare le barre porta carico dal tetto dopo ogni utilizzo.  
Attenzione : Utilizzare sempre degli accessori affidabili e ben conservati, verificando il corretto stato prima e dopo ogni utilizzo.  
Le barre da carico , possono essere utilizzate esclusivamente per gli utilizzi indicati dal costruttore.  
Conservare e leggere sempre le istruzioni di montaggio e di utilizzo.  
Gli accessori da tetto possono causare rumore o fischi durante il loro utilizzo.  
Non utilizzare mai questo prodotto , abbinato a tende da tetto di ogni tipo.  
Durante la marcia del veicolo , il prodotto deve sempre essere bloccato nei due sensi e chiuso a chiave (anche per piccoli spostamenti).  
Non superare mai la velocità massima indicata sulla prima pagina del manuale.  
In caso di dubbi sull'utilizzo o fissaggio del prodotto, contattare il distributore Green Valley più vicino.

GB Follow the assembly and usage instructions in the notice supplied.  
Keep this manual permanently. Maximum load weight is 75kg.  
The total permissible laden weight of the given motor vehicle may not be exceeded. The instructions of the motor vehicle manufacturer in respect of the maximum roof weight must be observed.  
Calculation of available roof load: Weight of roof rack + weight of roofbox + weight of payload = available roof load  
It is essential to ensure the load is safely and adequately fixed.  
The tightness of the fixation devices and security parts, and the roof rack load bars, as well as any additional accessories, must be checked once loaded and regularly during the journey. Retighten if necessary.  
Adhere to the manufacturer's instructions regarding the maximum authorised load on the vehicle.  
Adhere to the manufacturer's instructions regarding assembly and maximum authorised load of roof racks.  
In all cases, respect current regulations.  
The load must be evenly distributed over the roof rack and the centre of gravity should be as low as possible.  
Be careful to place heavy and narrow loads near to the rack's fixing points.  
Loads which overhang the roof rack must conform to current regulations and be properly secured.  
Any load carried on the roof of a vehicle significantly affects its behaviour, in particular its tolerance to side winds, its behaviour in bends and on braking. It is recommended to drive more carefully (reduce speed, be aware of increased braking distances).  
In order to reduce fuel consumption you are recommended to remove the roof rack after use.  
Attention: Secure the load correctly and safely.  
Use reliable and well-maintained material and check it is in good order before and after each use.  
The roof rack may only be used for the functions specified by the constructor.  
It is important to keep the assembly and usage instructions..  
Roof accessories can cause noise or turbulence during use.  
Do not fix the accessory to other brand's fixing systems.  
Never exceed the speed limit indicated on the first page of the manual.  
If you have any doubts about fixing or use please contact your nearest branch of the distributor. Green Valley.