

# TYPE F

## Ref.: 156.414



ISO/PAS 11154



CITY CRASH TEST



# n° 414



**FORD FOCUS s.w**  
**FORD MONDEO s.w**

**5**  
**5**

**03/2010>**  
**2012>2014**

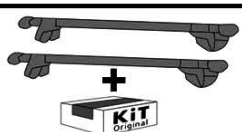

**5 kg + xx Kg = 75 kg max**

Charge maximale admissible indiquée sur la boîte de KIT. Ne pas dépasser la charge maximale autorisée par le constructeur du véhicule

Il Carico massimo ammissibile è indicato sulla scatola del KIT. Non superare il carico massimo consentito dal costruttore del veicolo

Carga máxima admisible indicada en la caja de las KIT. No exceda la carga máxima permitida por el fabricante del vehículo.

Maximum allowable load indicated on the box of KIT. Do not exceed the maximum load allowed by the vehicle manufacturer.

Maximal zulässige belastung angegeben auf der box der KIT. Überschreiten sie nicht die maximale belastung durch den fahrzeughersteller zugelassen.

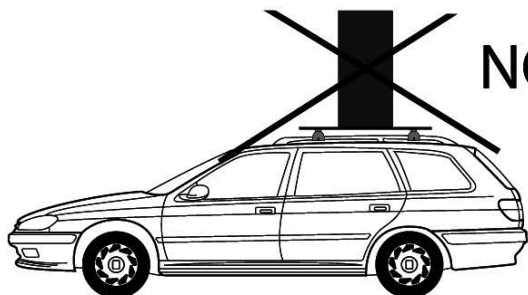
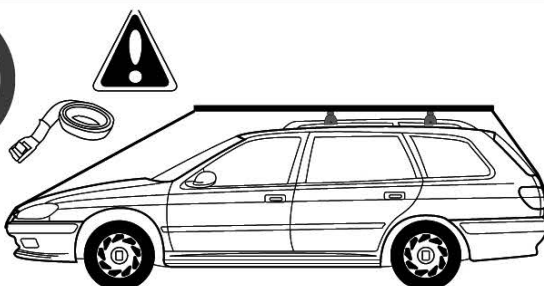
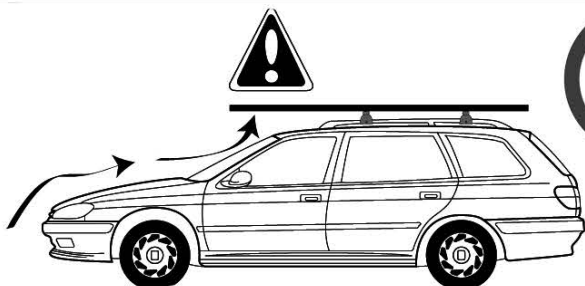

**NO**

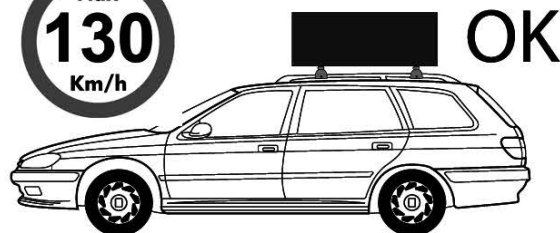

**OK**

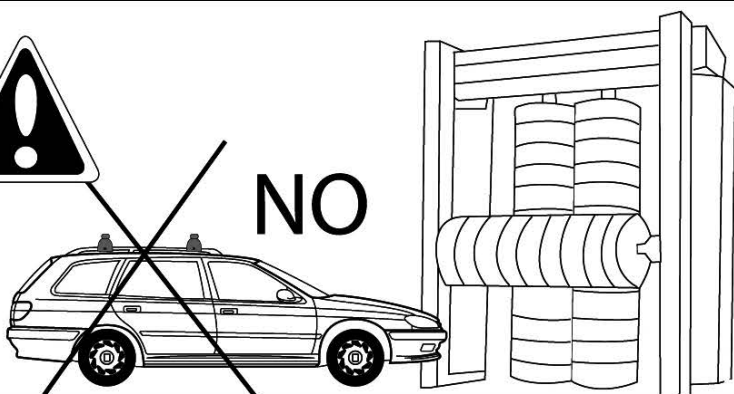

**NO**

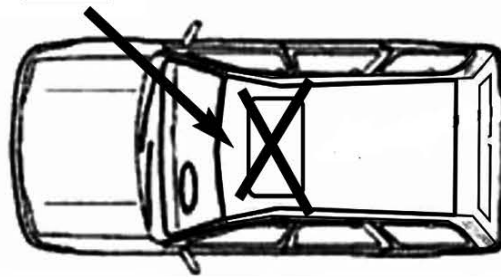

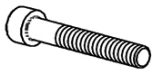

M6x20  
x4



5588.06  
x4



6592.06  
x4



100005  
x1

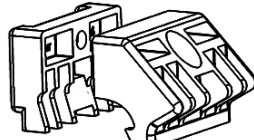

1641407  
x4

1741407  
x4



3540827  
x4

1

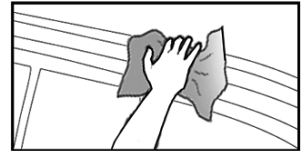
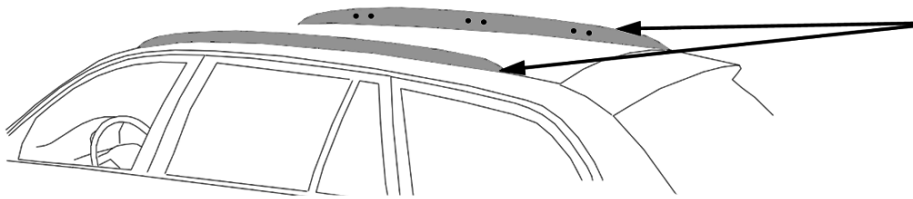

2

1)

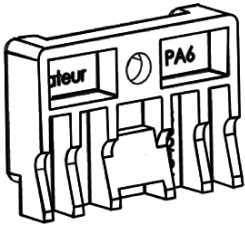

2)

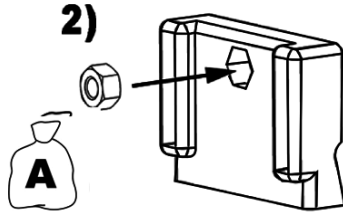

3)

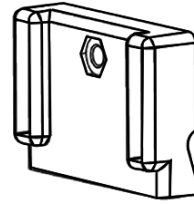

x4

3

700 mm

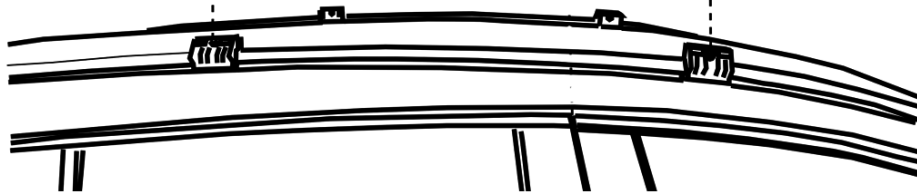

A)

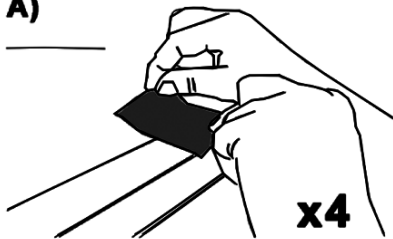

x4

B)

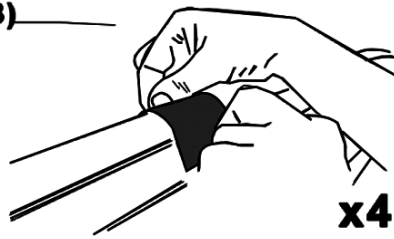

x4

C)

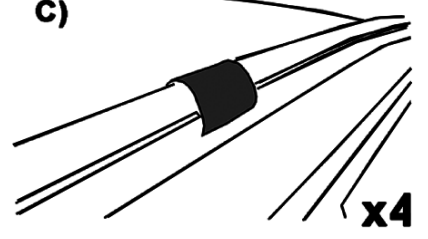

x4

D)

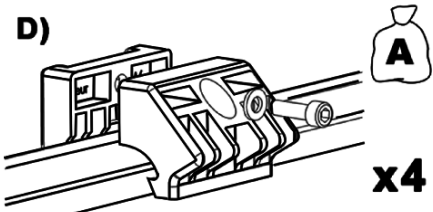

x4

E)

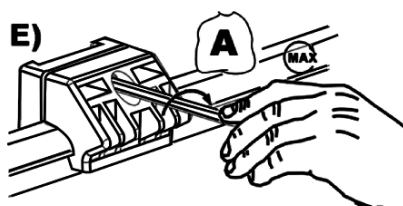

x4

F)

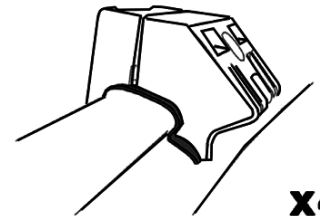

x4

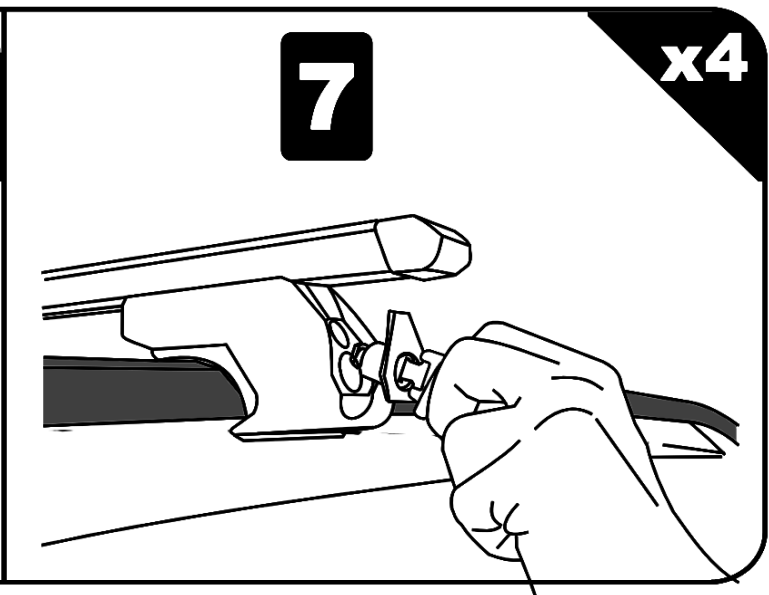
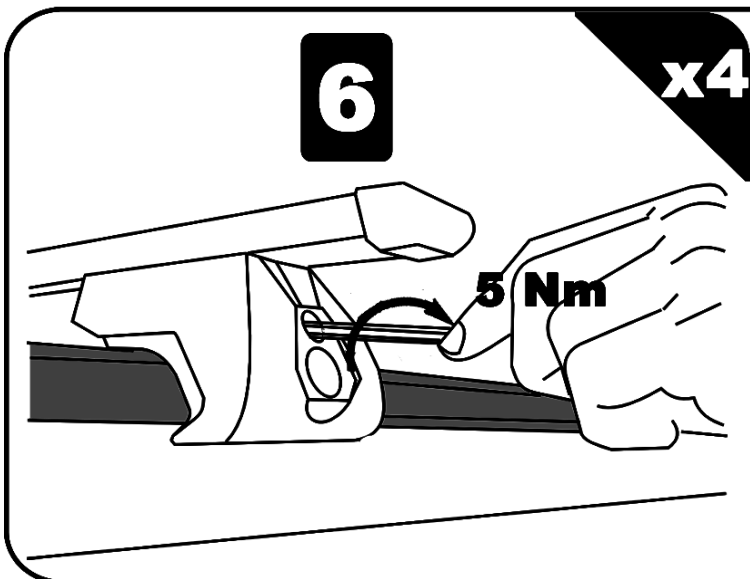
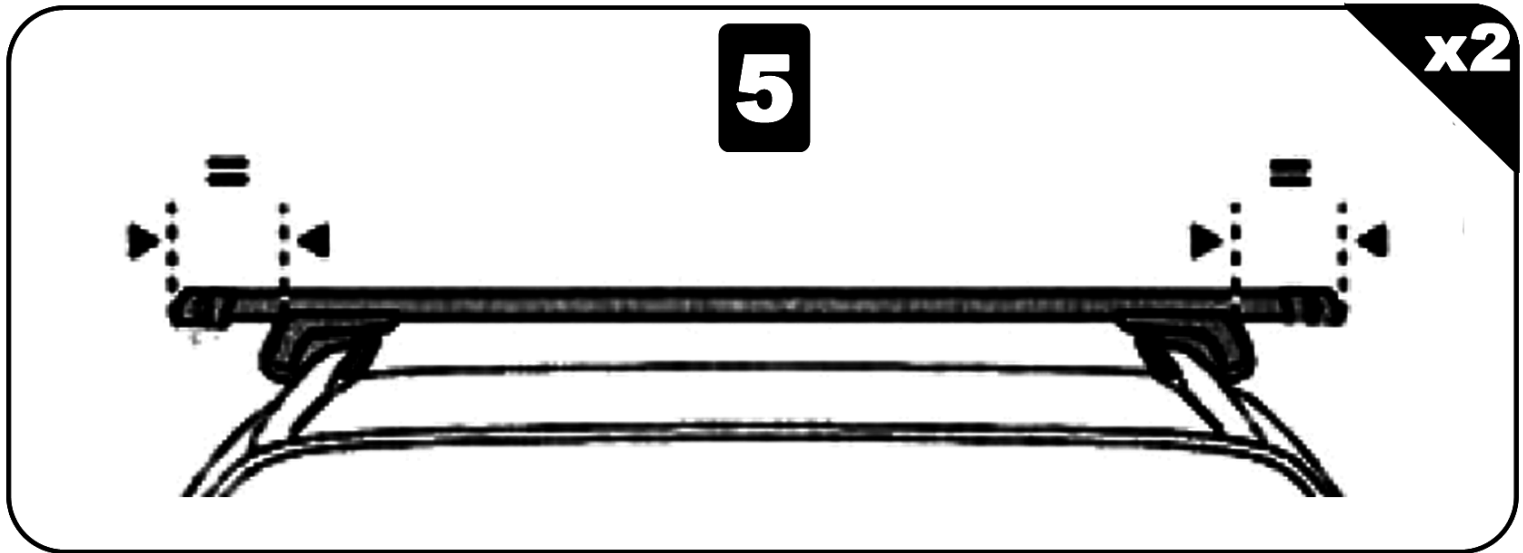
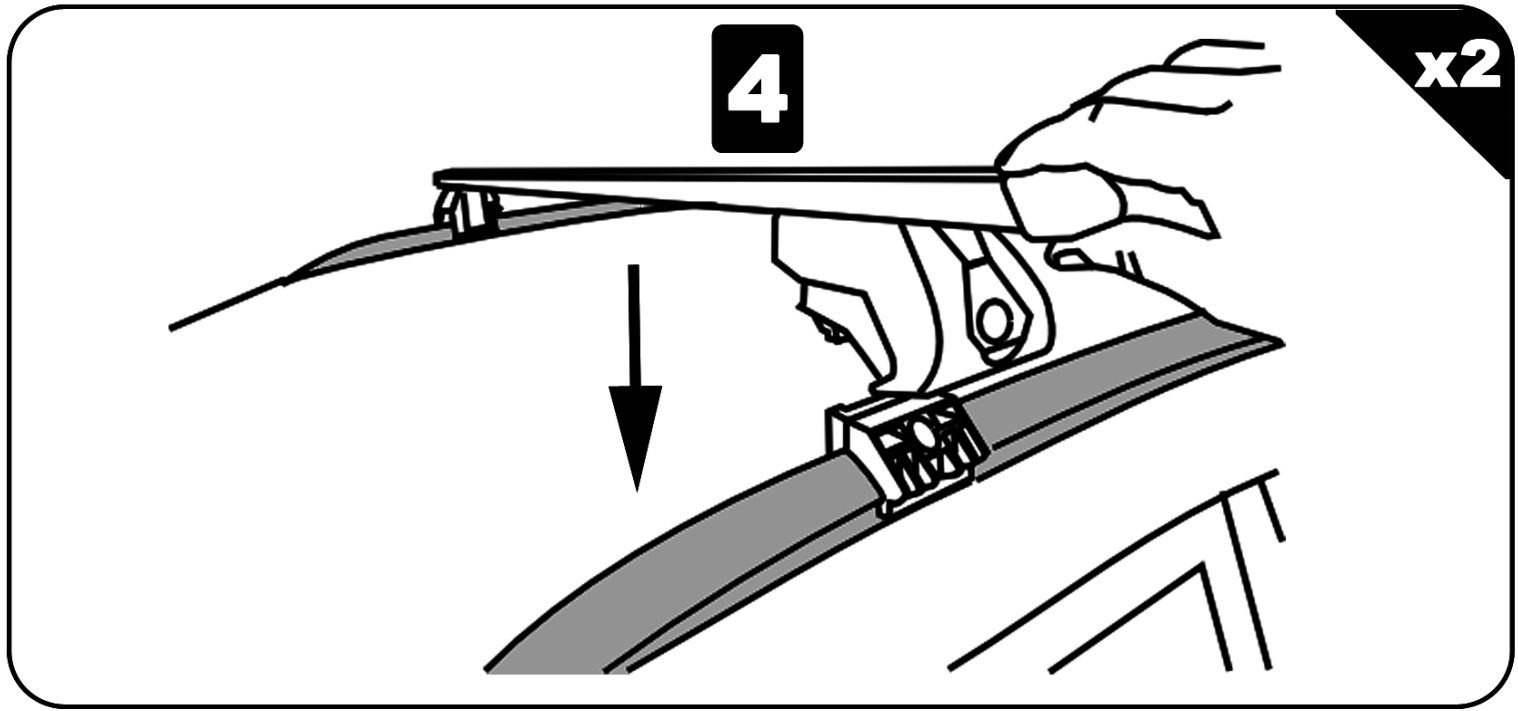

**FR:** Charge maxi 75 kg ne pas dépasser la charge maximale admissible par le constructeur du véhicule.  
**IT:** Carico massimo 75 kg non superare il carico massimo sul tetto indicato dal costruttore del veicolo  
**SP:** Capacidad máxima de carga 75 kg no exceda la maxima carga permitido por el fabricante del vehículo.  
**PT:** Capacidade máxima de carga 75 kg não exceder a carga máxima permitida pelo fabricante do veículo.  
**EN:** Maximum carrying capacity 75 kg do not exceed the maximum allowable load by the vehicle manufacturer.  
**DE:** Zulässige höchstlast 75 kg überschreiten sie nicht die maximale belastung zulässige vom fahrzeughersteller.  
**NL:** Maximaal toegestaan 75 kg neem niet meer de maximale belasting toegestane door de voertuigfabrikant.

**CHECK!!**

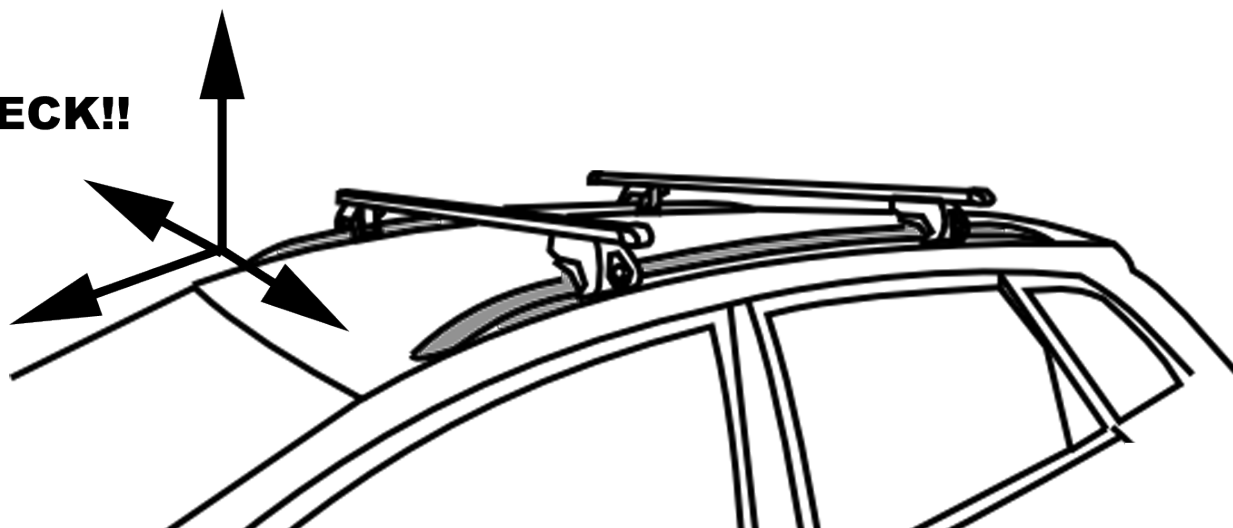

**FR :** Pour le démontage, réaliser à l'inversement ces étapes.  
**IT :** Per smontare la barre seguire le fasi al contrario .  
**EN :** For disassembly, perform these steps in reverse.  
**ES :** Para desmontar, siga estos pasos a la inversa.  
**PT :** Para desmontar, execute estas etapas em ordem inversa  
**NL :** Uit elkaar te halen, voert u deze stappen in omgekeerde.  
**DE :** Zu zerlegen, diese Schritte in umgekehrter

  
**Green Valley**®  
S m a r t m o b i l i t y

Aurilis Group Sa , Rue Pierre Boulanger, ZI le Brezet, 63000 CLERMONT FERRAND , FRANCE

[www.aurilisitalia.com](http://www.aurilisitalia.com)

MG 01/17