

TYPE F

Ref.: 156.419



ISO/PAS 11154



CITY CRASH TEST



n° 419



Fiat Panda III

5

01/2012->

Fiat 500X

5

01/2015->

 } **5 kg** + **xx Kg** = **75 kg max**

Charge maximale admissible indiquée sur la boîte des barres de toit. Ne pas dépasser la charge maximale autorisée par le constructeur du véhicule

Il carico massimo ammissibile è indicato sulla scatola delle barre. Non superare il carico massimo consentito dal costruttore del veicolo

Carga máxima admisible indicada en la caja de las barras de techo. No exceda la carga máxima permitida por el fabricante del vehículo.

Maximum allowable load indicated on the box of roof bars. Do not exceed the maximum load allowed by the vehicle manufacturer.

Maximal zulässige Belastung angegeben auf der box der dachreling. Überschreiten sie nicht die maximale belastung durch den fahrzeughersteller zugelassen.

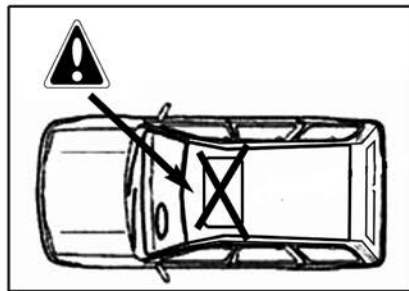
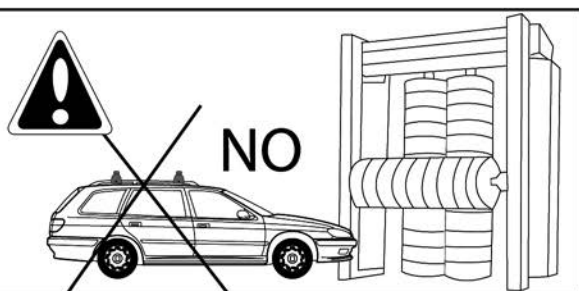
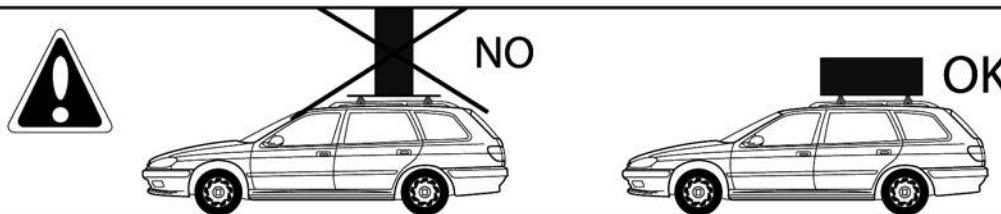
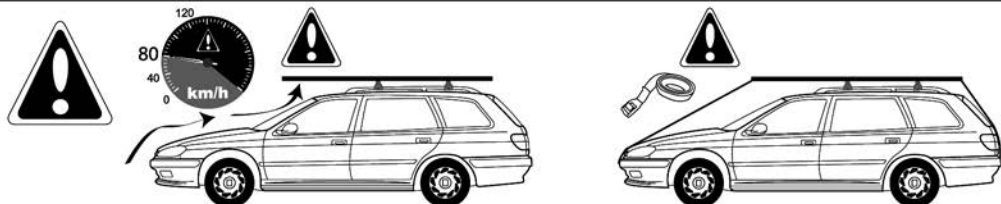

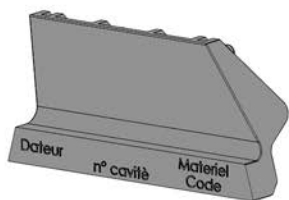

x4
1641907

1



2

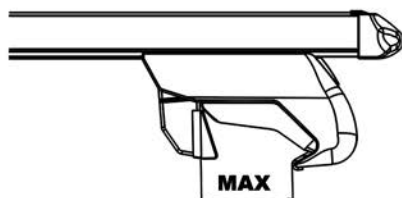
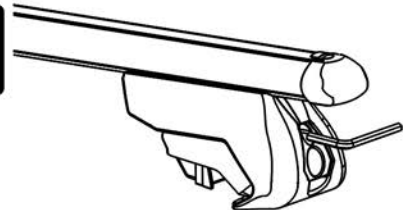

x4

3

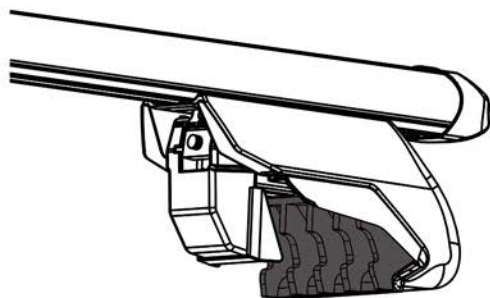

x4

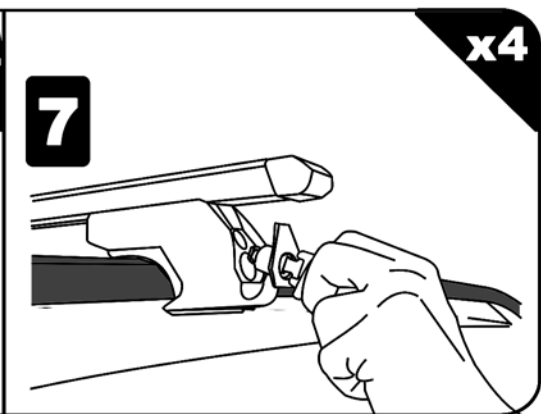
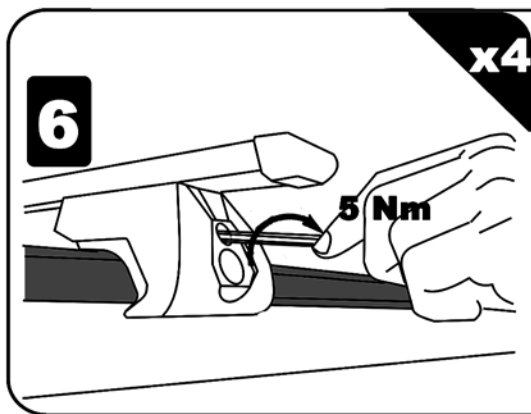
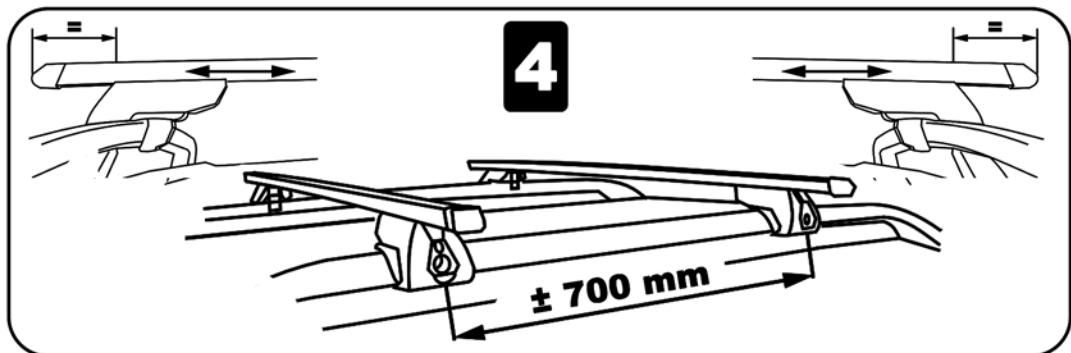

FR : Charge maxi 75 kg ne pas dépasser la charge maximale admissible par le constructeur du véhicule.
IT : Carico massimo 75 kg non superare il carico massimo sul tetto indicato dal costruttore del veicolo
SP : Capacidad máxima de carga 75 kg no exceda la maxima carga permitido por el fabricante del vehículo.
PT : Capacidade máxima de carga 75 kg não exceder a carga máxima permitida pelo fabricante do veículo.
EN : Maximum carrying capacity 75 kg do not exceed the maximum allowable load by the vehicle manufacturer.
DE : Zulässige höchstlast 75 kg überschreiten sie nicht die maximale belastung zulässige vom fahrzeughersteller.
NL : Maximaal toegestaan 75 kg neem niet meer de maximale belasting toegestane door de voertuigfabrikant.

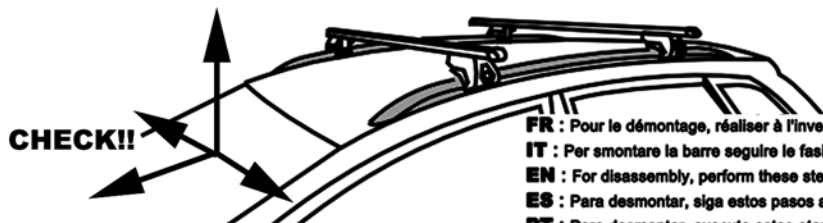

FR : Pour le démontage, réaliser à l'inversement ces étapes.
IT : Per smontare la barra seguire le fasi al contrario .
EN : For disassembly, perform these steps in reverse.
ES : Para desmontar, siga estos pasos a la inversa.
PT : Para desmontar, execute estas etapas em ordem inversa
NL : Uit elkaar te halen, voert u deze stappen in omgekeerde.
DE : Zu zerlegen, diese Schritte in umgekehrter

